

DK

**指定病院及び指定老人ホーム等
指定施設における不在者投票の事務処理要領**



DK CB CE
DK CB DD
DK CB
DK CB DD
DK CB CB DC CH
DK CB CF CB DC

;

DK



2

C

2

C

-

2

D

-

F

-

C

H

D

I

E

J

F

CB

G

CD

H

CF

I

CG

--

C

CH

D

CH

E

DB

F

DD

G

DH

H

DI

--

C

DJ

D

DK

E

EB

--

EC

—
—

C	EG
D	EH
E	EI
F	EJ
G	EK
H	FB
I	FC
J	FD
K	FE
CB	FF
CC	FG
CD	FH
CE	FI

—
—

C	FJ
D	FK
E	GB
F	GD

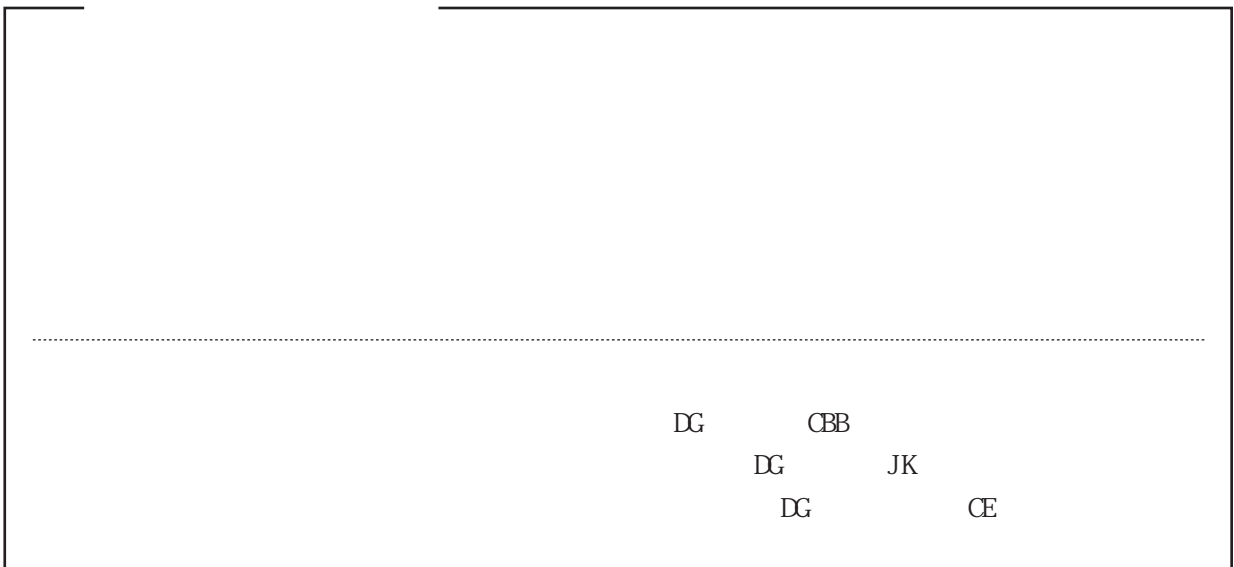

CB

CB DC

CH

EB

DK CB

CH

CB CF

CB DC

EB

DK CB CD

CH

-
-

—



CG

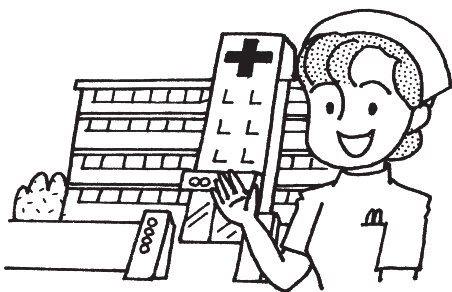
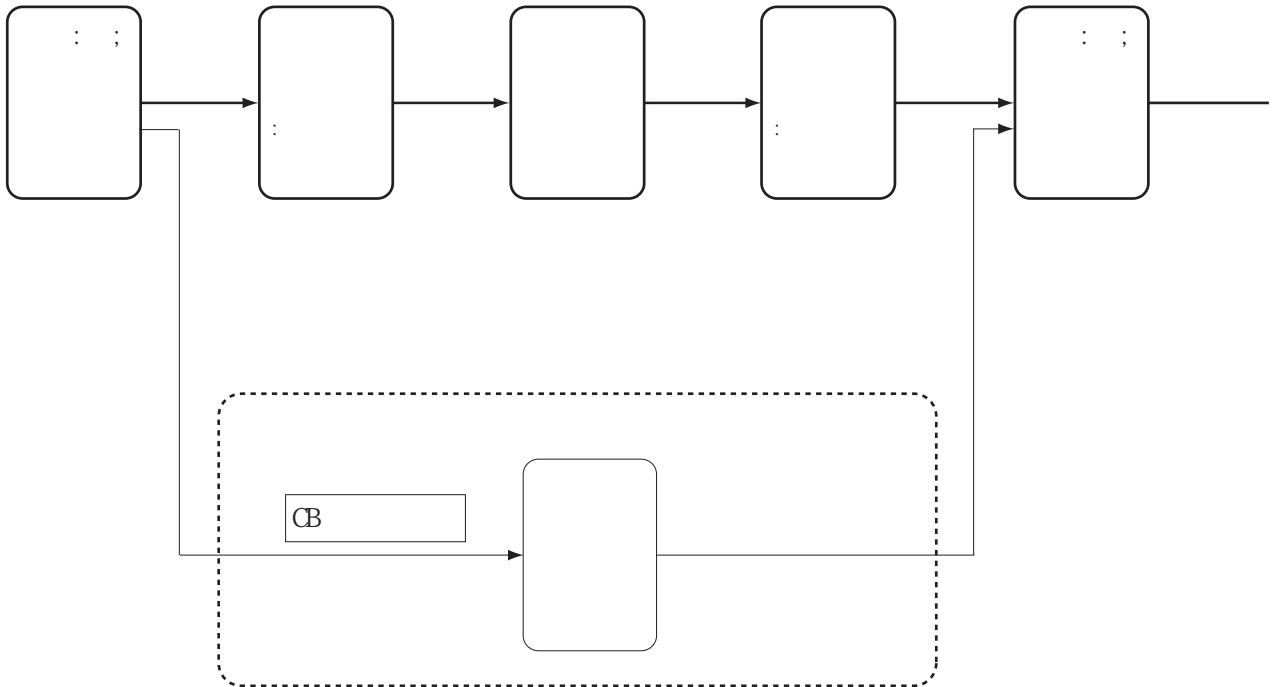



CH Ⅱ



DJ

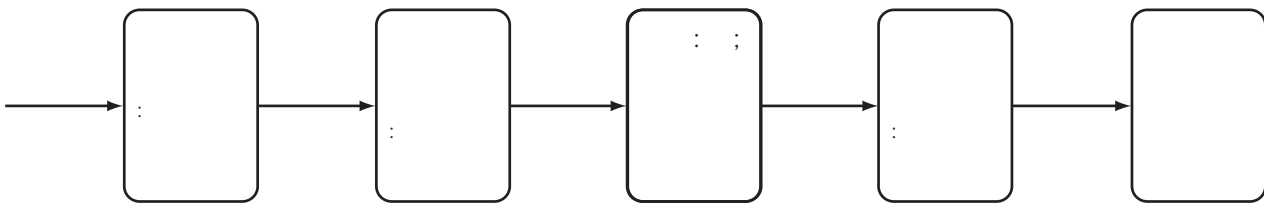

EB

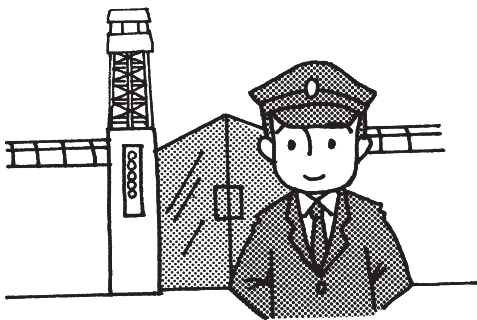
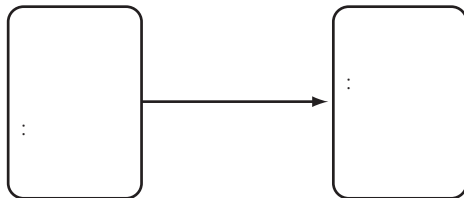

—
—

—
—

GG





: GG

Eight empty rounded rectangular boxes stacked vertically.

CB
CB
CF
CD
CH
DD
DJ



◆ ◆

_____ : CG

: CEG



=

:G

:D

FJ

:G

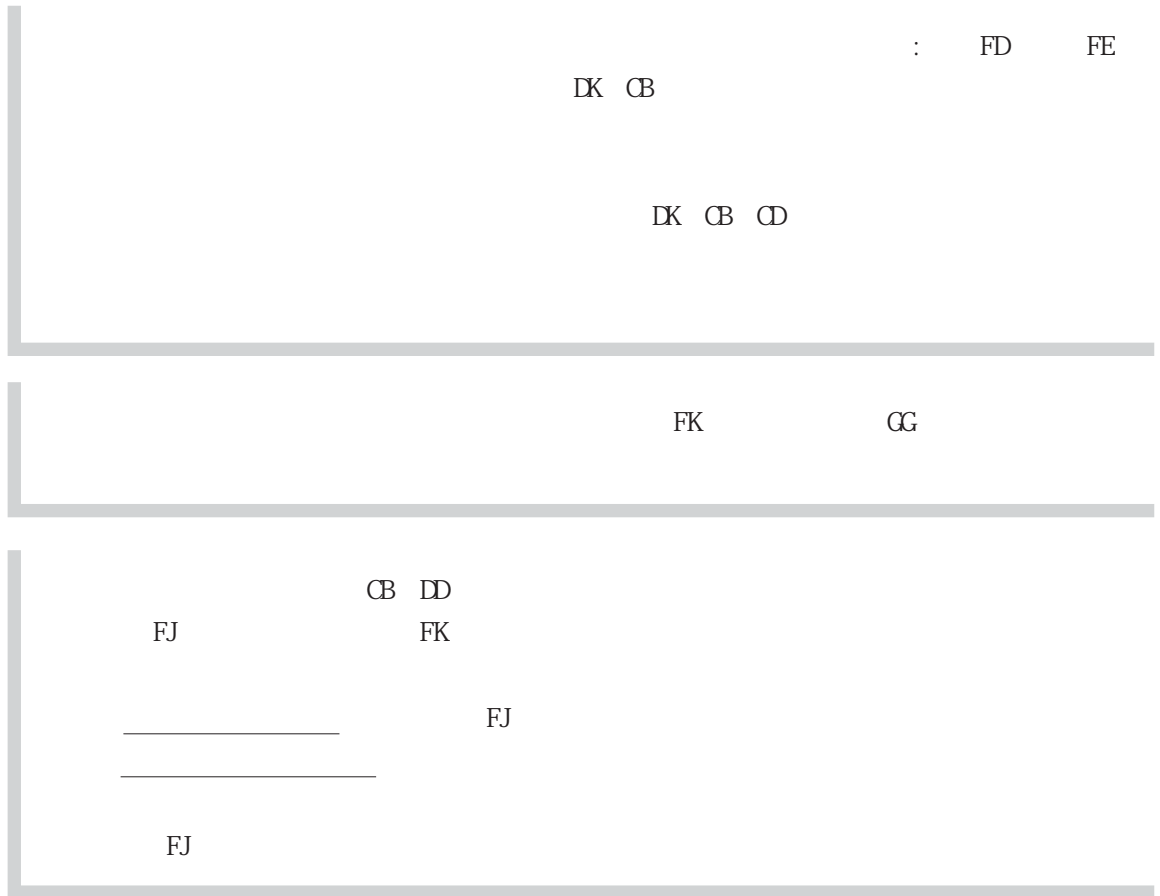

:D

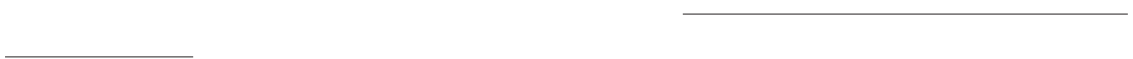

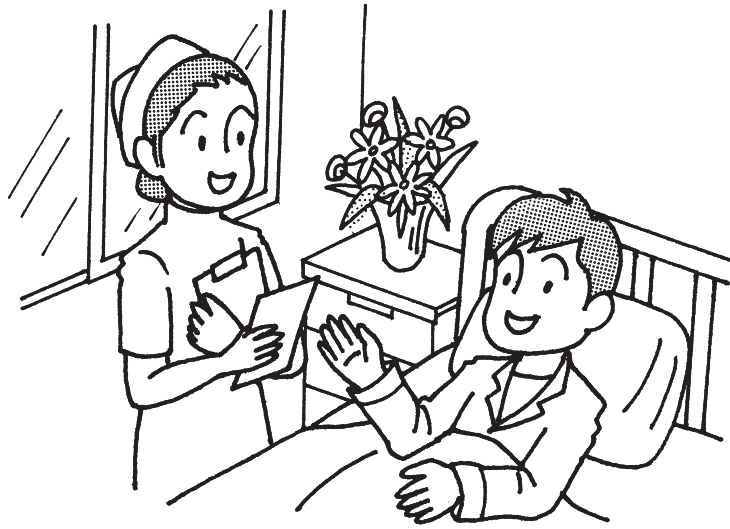

GB

:G

_____”

„CF

„EK

: „FB

: ;

:D

;

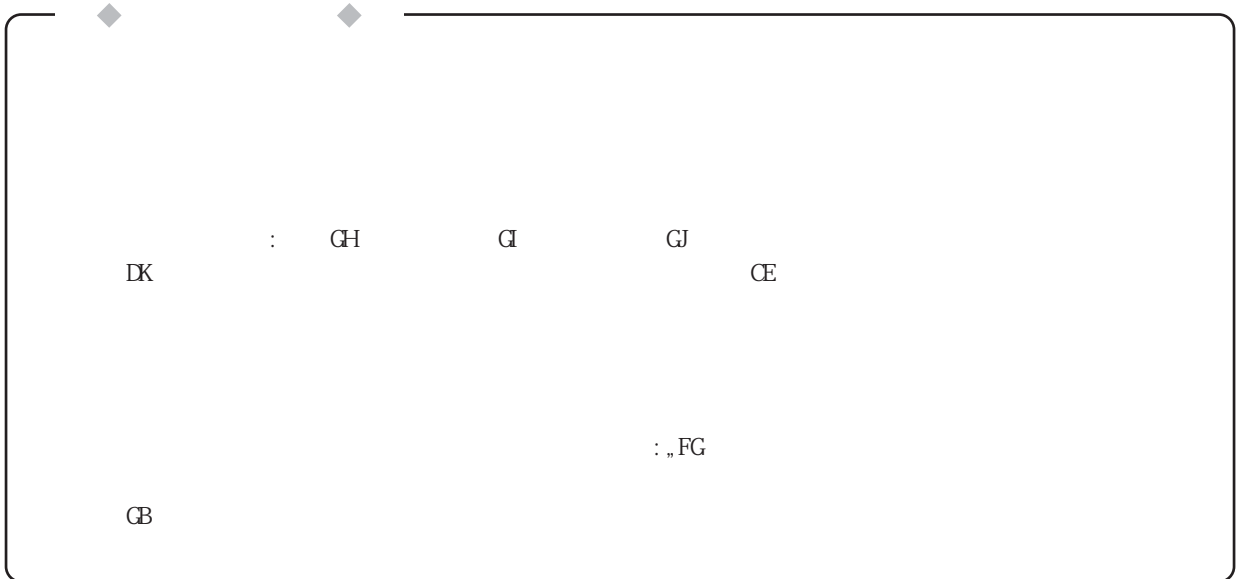
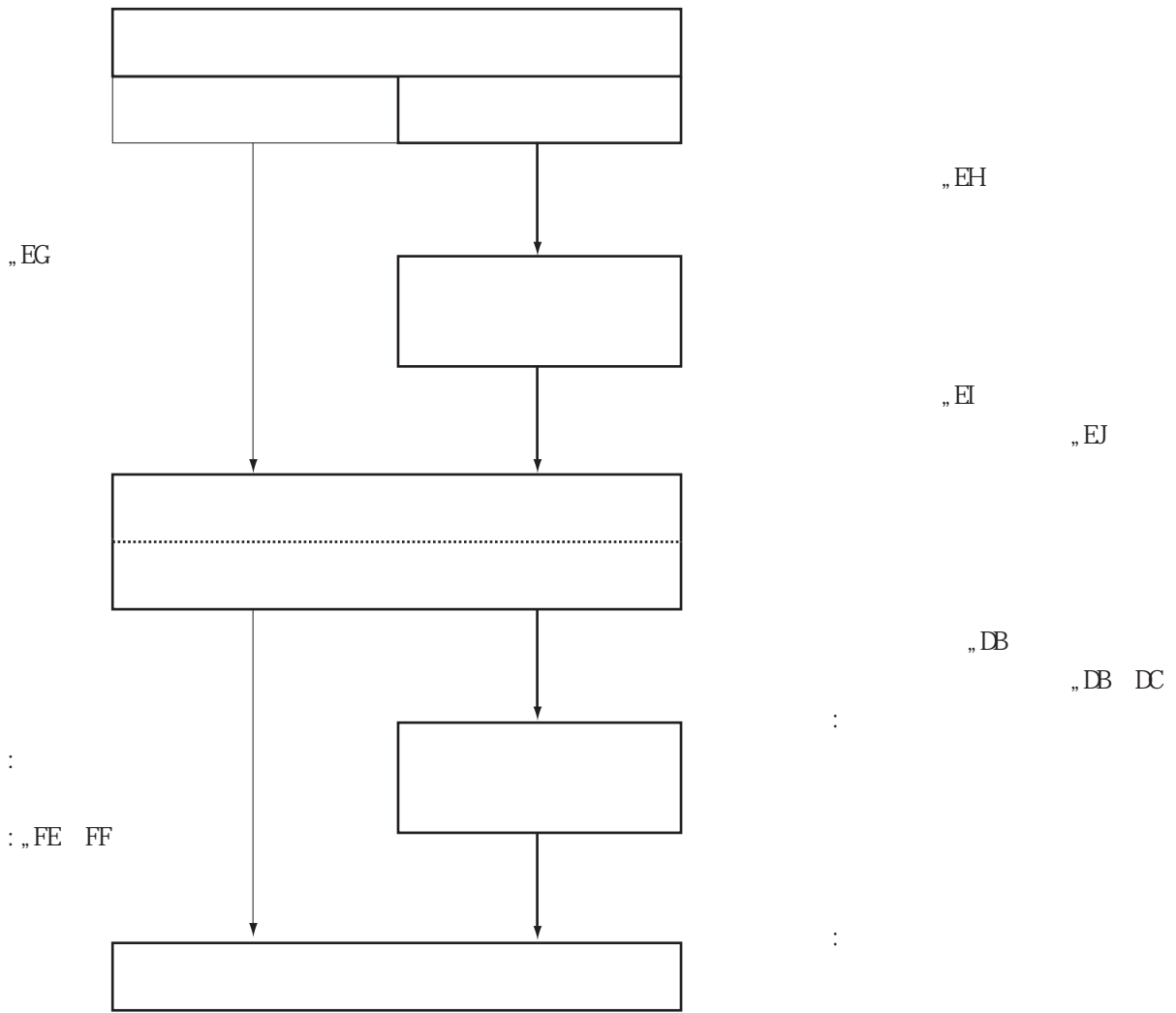

DBC CC

CFG

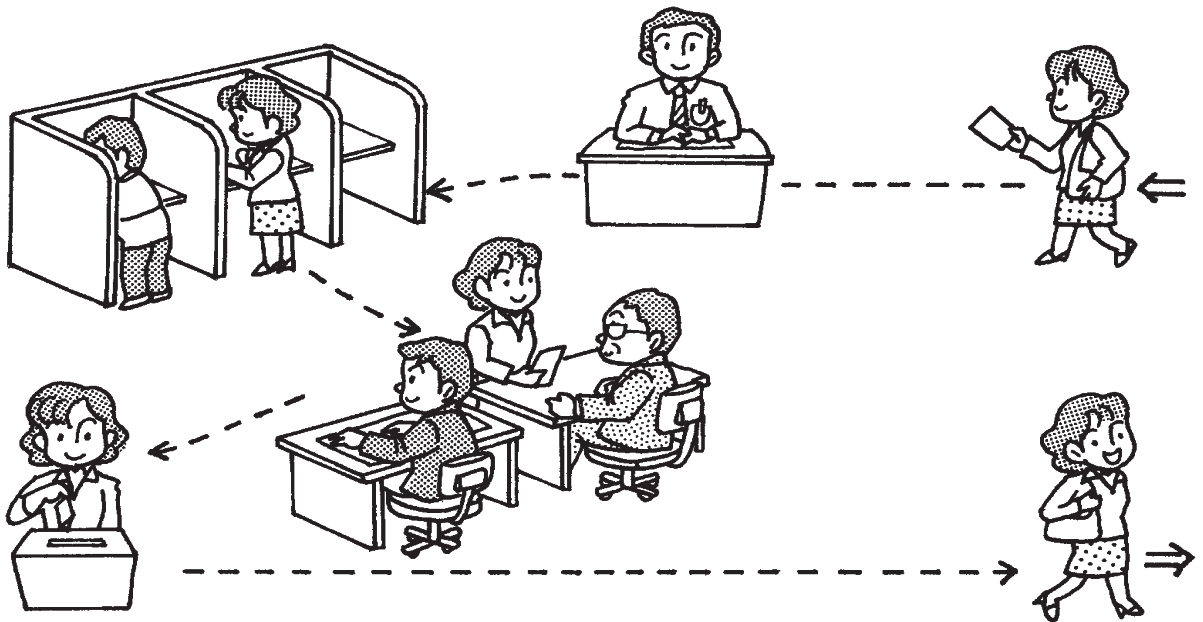

CG

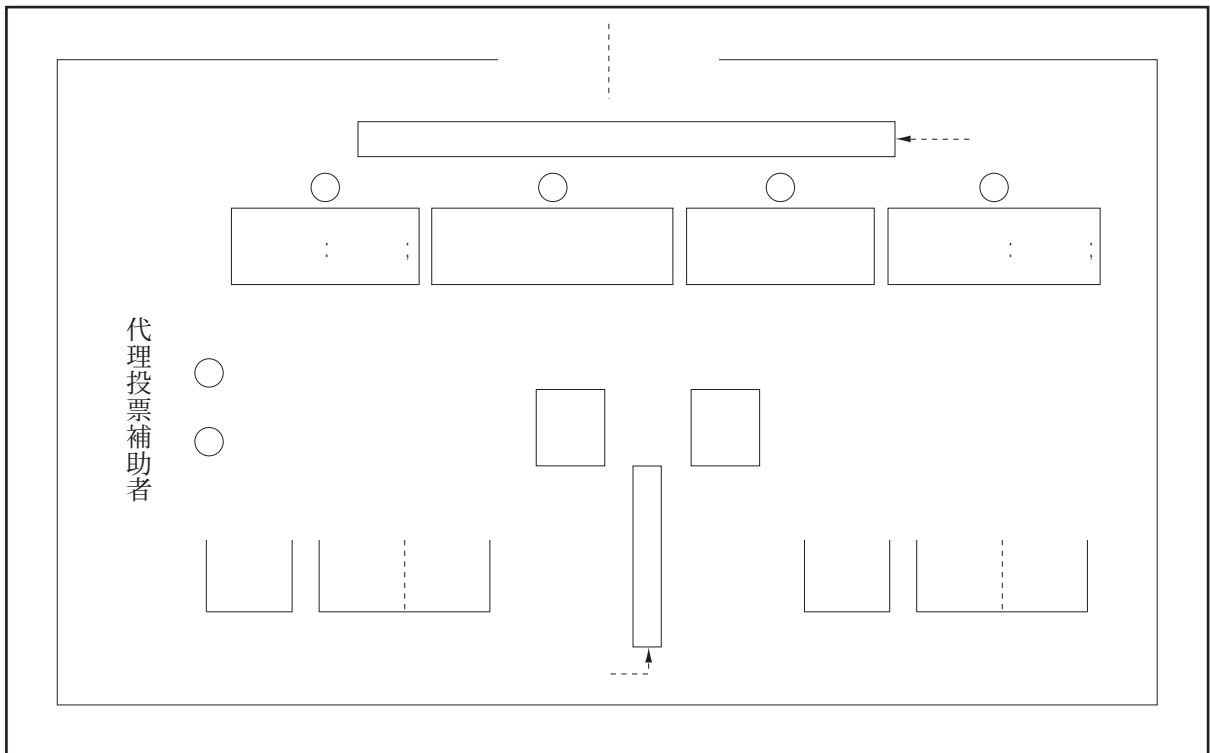
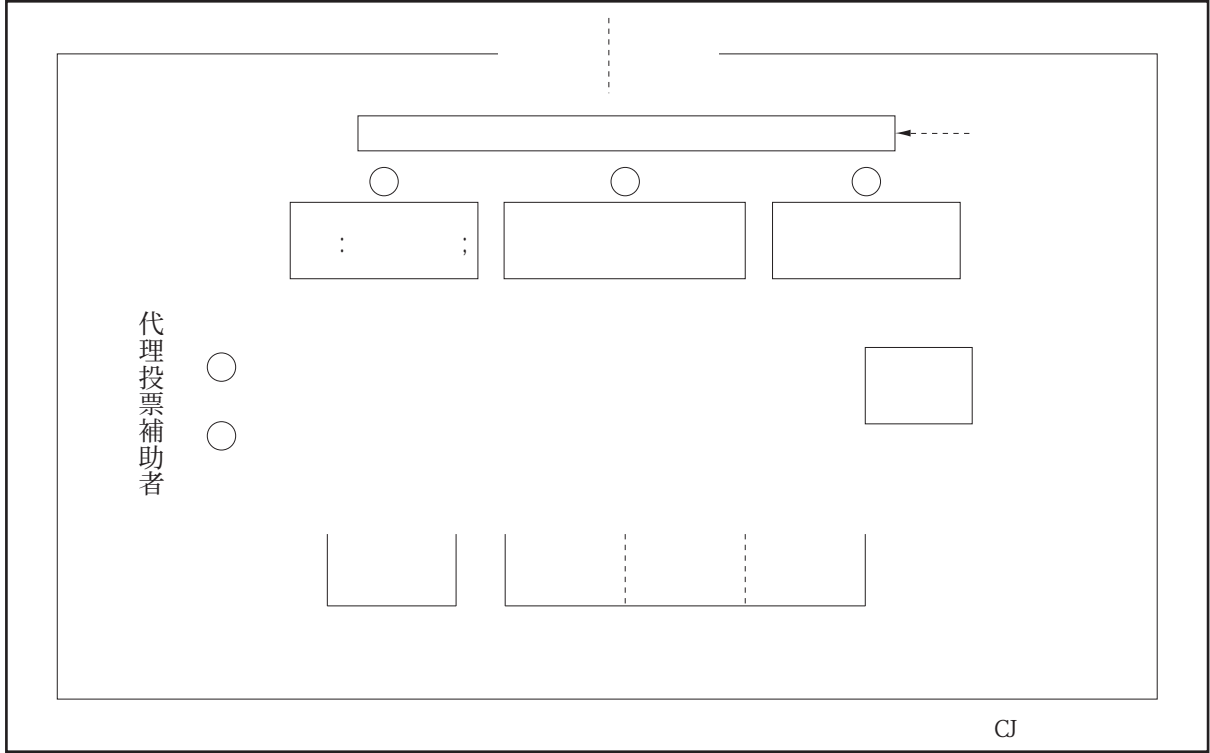

:C

:D

:E

:C

„FI

CB>I BB

:D

CB>I BB

--

-

—

GJ

: DB

EB

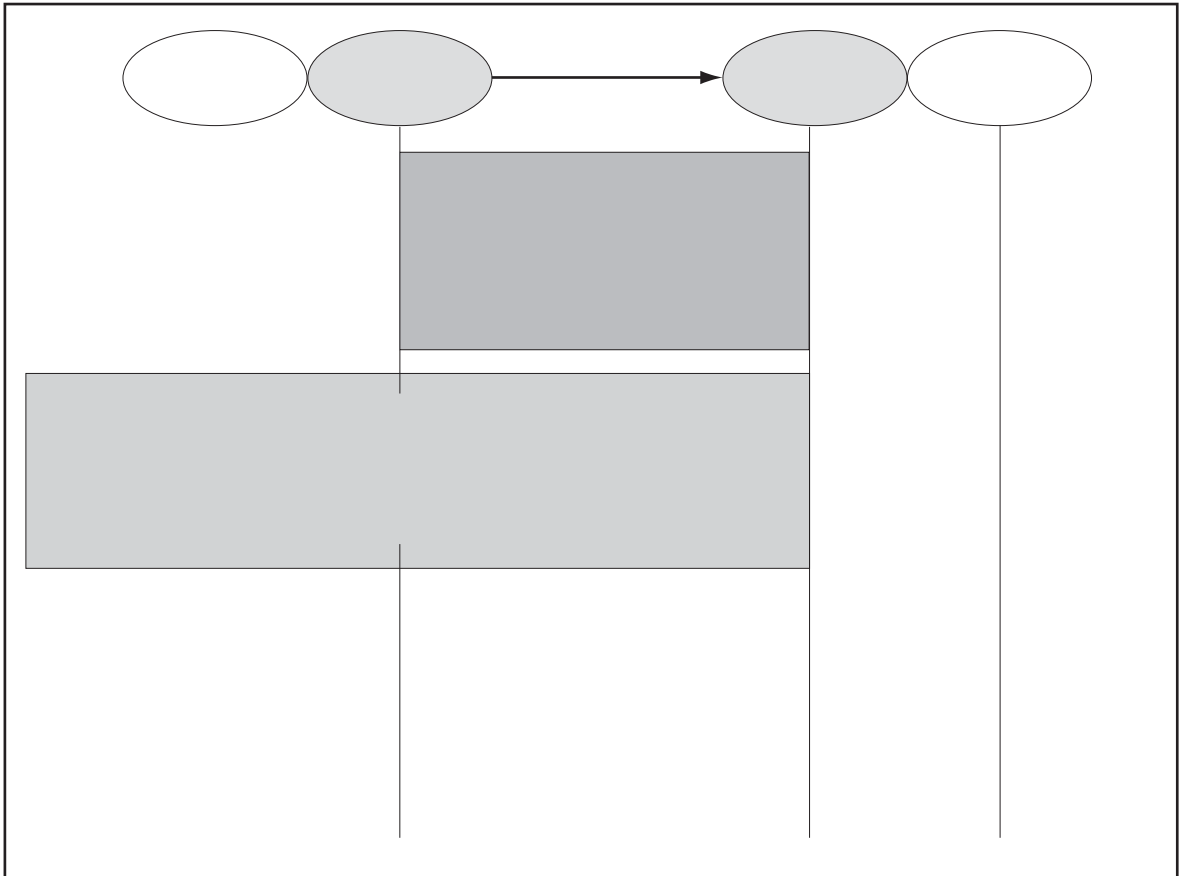

: G

„FC

„DB

„DB

DC

„FE FF

:D

--

DD

:E

--	--

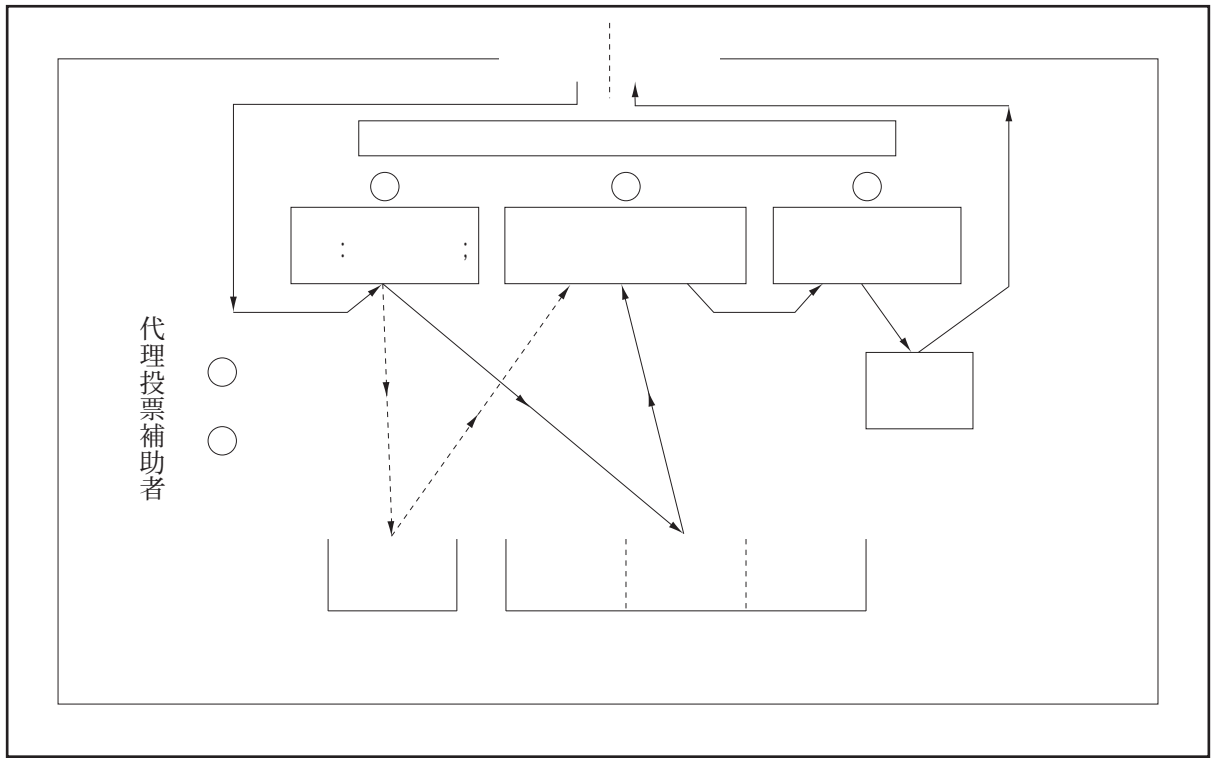



„DB

: „DB DC

:

: „FE FF

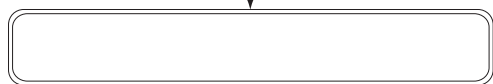

„DD

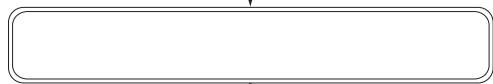

〇〇〇〇〇〇〇〇〇選挙投票

県選挙管
理委員会
之印

〇 注 意

- 一 候補者の氏名は、欄内に一人書くこと。
- 二 候補者でない者の氏名は、書かないこと。

注意 この封筒には、何も記載しないでください。
この封筒に記載済みの投票用紙を入れ、封をした
うえ、外封筒に入れてさらに封をしてください。

投票年月日
投票場所
不在者投票管理者

平成〇年〇月〇日
〇〇〇〇病院
仙台次郎

立会人
石巻三郎

DK CB DD

県選挙管理委員会
之印

投票者
宮城太郎

(代理投票の仮投票における
代理記載人氏名)

注意
投票者欄の氏名は必ず自分で書いてください。

:G

--	--

	DF	:D
--	----	----

„FC

: „FD

◆	◆
---	---

投票年月日
投票場所
不在者投票管理者

平成〇年〇月〇日
〇〇〇〇病院
仙台次郎

立会人
石巻三郎

DK CB DD

県選挙管理委員会之印

注意
投票者欄の氏名は必ず自分で書いてください。

投票者
宮城太郎

(代理投票の仮投票における代理記載人氏名)

:D

„FD

„FC



投票年月日 平成〇年〇月〇日

投票場所 〇〇〇〇病院

不在者投票管理者 仙台次郎

立会人 石巻三郎

DK CB DD

県選挙管理委員会之印

投票者 宮城太郎

代理投票の仮投票における代理記載人氏名 塩竈四郎

注意 投票者欄の氏名は必ず自分で書いてください。

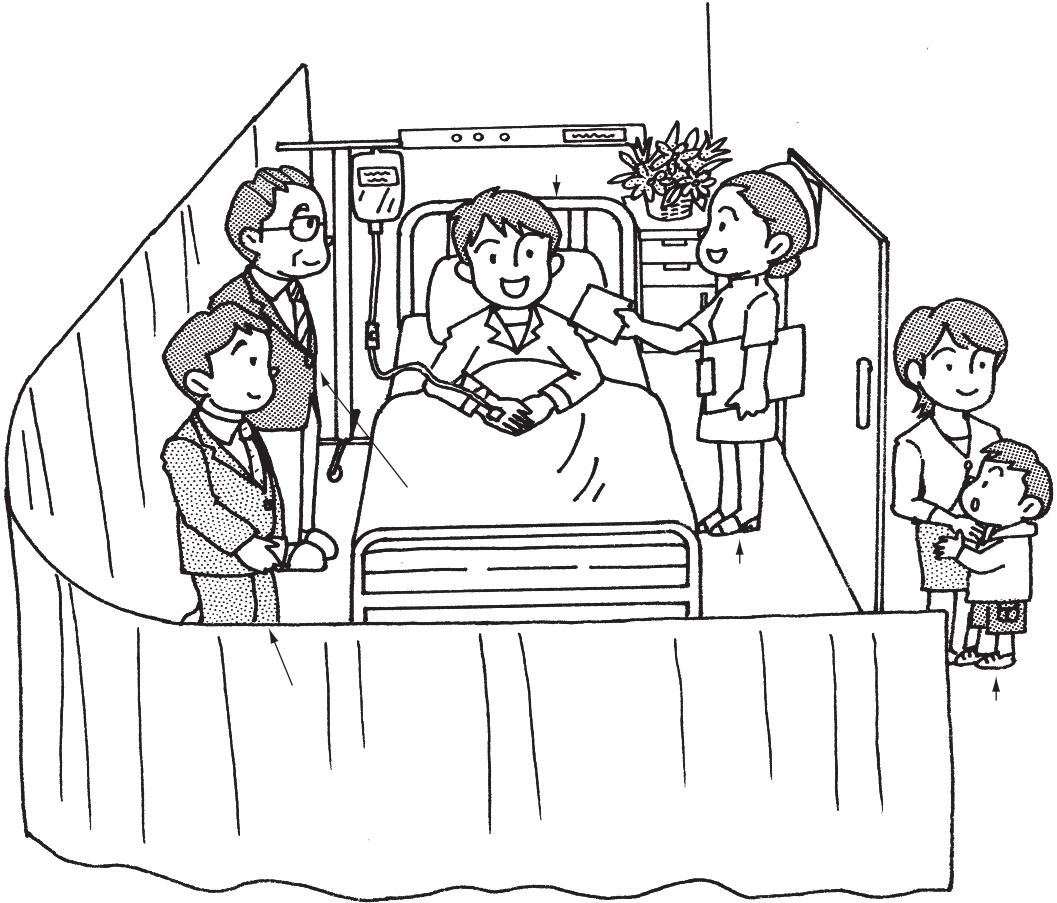



--

--

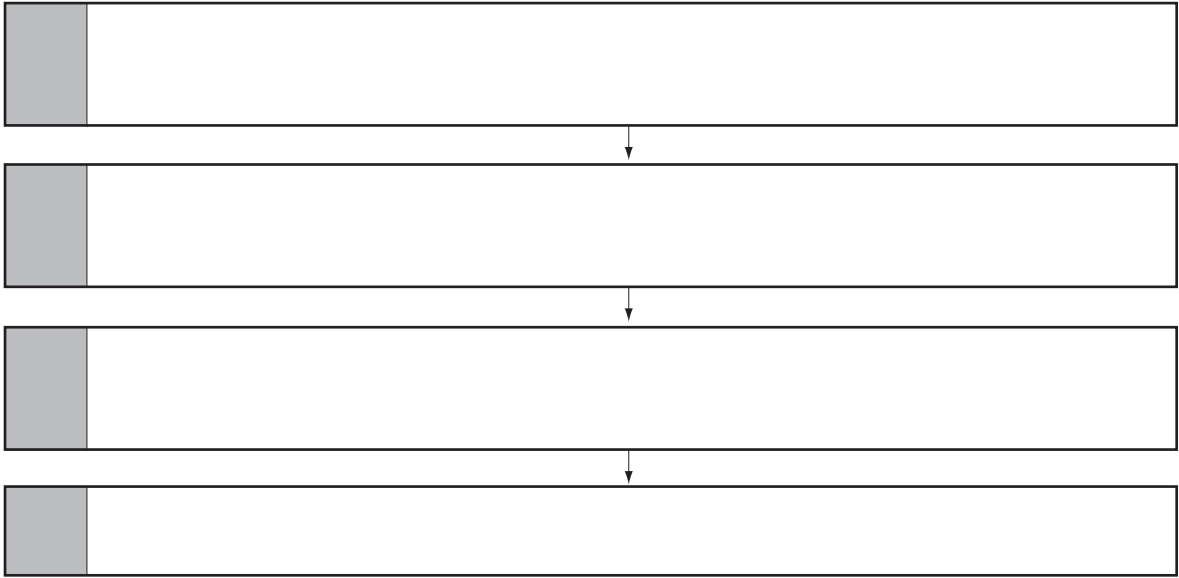

:

CC CD

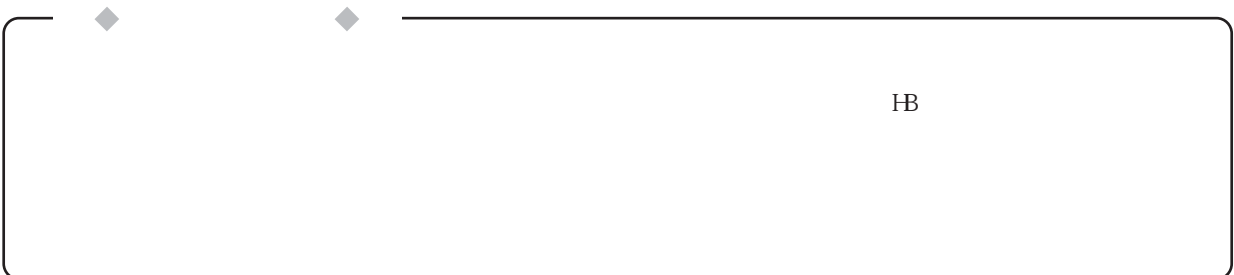

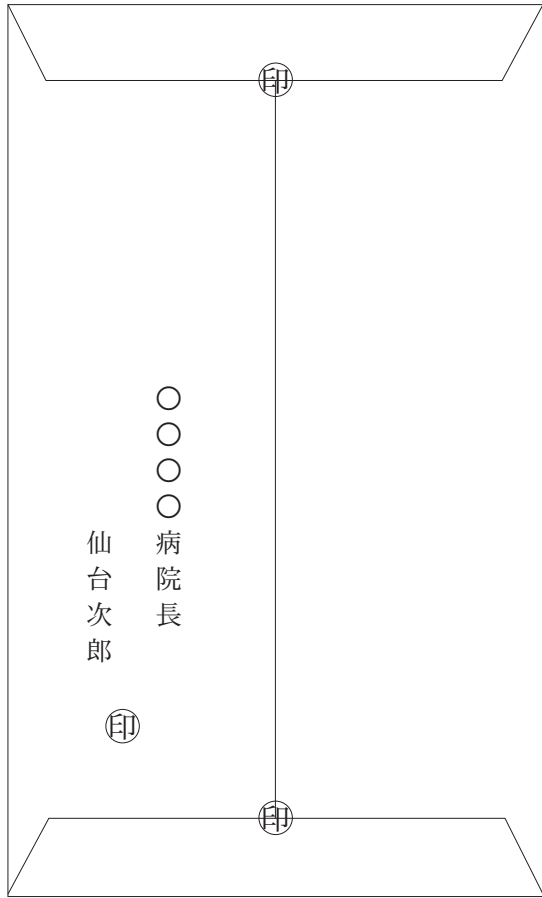
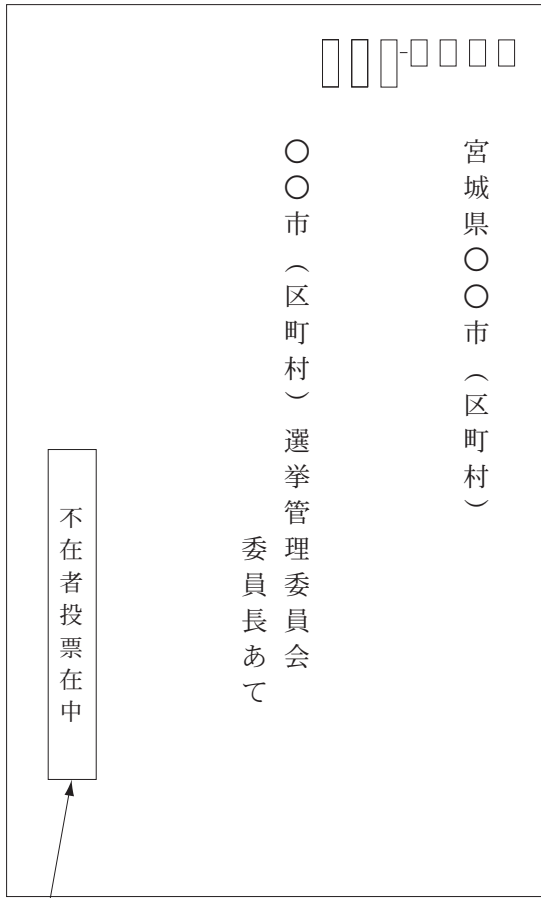

	„EH
	„EI
	„EJ
	„FC
	„FD
	„FH
	„FI

		2 2

	IGE
--	-----

--	--

N

P

„FH
„EJ
„FI

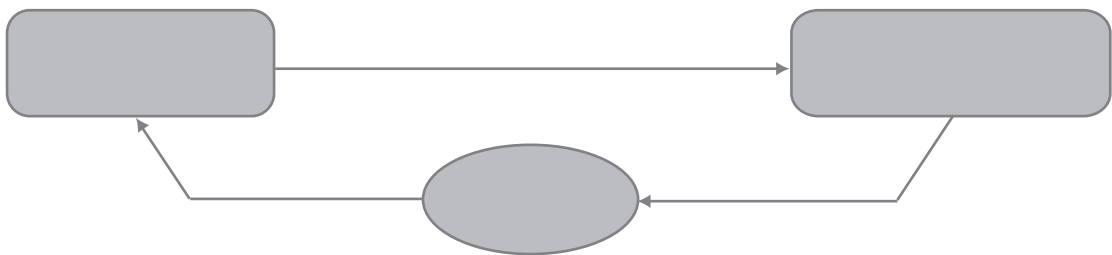

--
-

--

■

■

■

CB

CC

CD

CE >

CF

CG

CH

CI

CJ

CK

DB

DC

DD

DE

EF

- -
-

;

[]

GB

	[]	[]
	[]	[]
①	① []	[]
		;

		:	

== : :



DK CB DD { 2 2 2 2 2 2 }

: ;

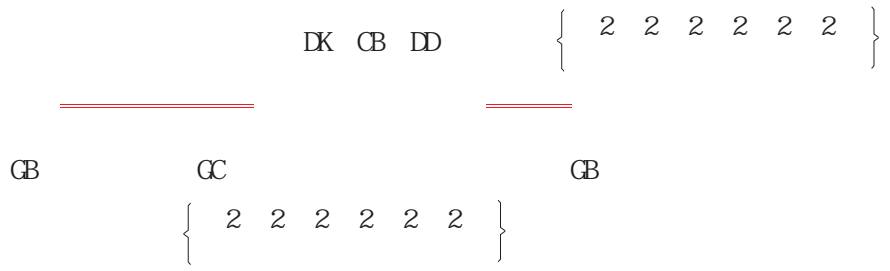

= ; = ; :

:



GB





A table with two columns and four rows, all cells are empty. It is located in the center of the page.

: :

(規則第十二号様式)

不在者投票証明書

選挙	その他の事項	投票をしようとする病院、老人ホームその他の施設の名称	選挙人の生年月日	選挙人の氏名
平成〇年〇月〇日執行 〇〇選挙	〇〇〇〇	〇(何道府県) 〇郡(市) 〇区 〇町(村) 〇番地 〇〇〇〇病院	〇年 〇月 〇日生	

右のとおり証明する。

平成 〇年 〇月 〇日

〇(何道府県) 〇郡(市) 〇区 〇町(村) 選挙管理委員会委員長 (氏名) 印

注意 この封筒は、開かずそのまま不在者投票管理者に提出してください。
開封すると不在者投票はできません。

選挙人（氏 名）

不在者投票証明書在中

〇〇〇選挙
管理委員会
委員長之印

〇〇〇選挙管理委員会
委員長
（氏 名）
印

CC

bCC

:

:

CD

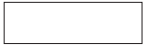

DK CB DD { 2 2 2 2 2 2 }

BDD



F>GCJ

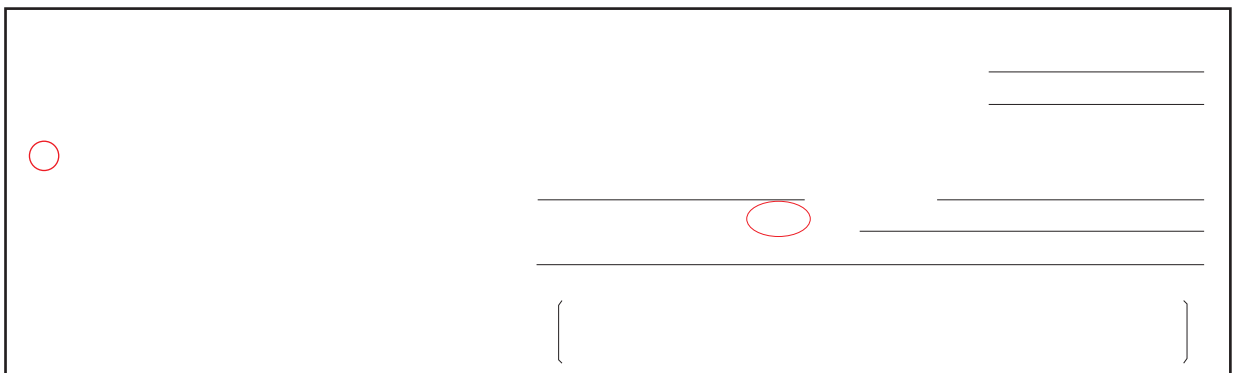

:s;	:t;	:s; :t;	
	IGE	F>GCJ	

— —
—
—————

DK

		DK	EB	EC	ED	EE	DK	EB	EC	ED	EE
		@DC							@DI		
						@DJ		@DI			
				@CB				@CB			
			@K					@K			
					CC@CE			@EB			
					@DF				@EC		
					@			@EB			
			@I					@CB			
			@D						@CC		
CB						@DJ					@DJ
CC						@EB					@EB
CD						@DJ					@DJ
CE			@K					@K			
CF				@B				@CB			
CG					CB@				@		
CH			@E					@E			
CI					CB@I						@EB
CJ				@I				@I			
CK			@D								@EC
DB				@I						@EC	
DC				@CE					CC@EB		
DD			@I						CC@D		
DE			@F						CC@D		
DF				@B			CD@F				
DG				@B					@CB		
DH			@						@CB		
DI				CB@						@EC	
DJ		@							@CB		
DK				@G					@G		
EB				@I						@	
EC				@I							@EC
ED				@EB					CD@EC		
EE			@					@			
EF				CC@D					CC@D		
EG		CC@					CC@				

	EB	CD	CE
	EC		DJ
	EF		DG
	DK	CC	DB
	EC	CC	CD

: C
: D

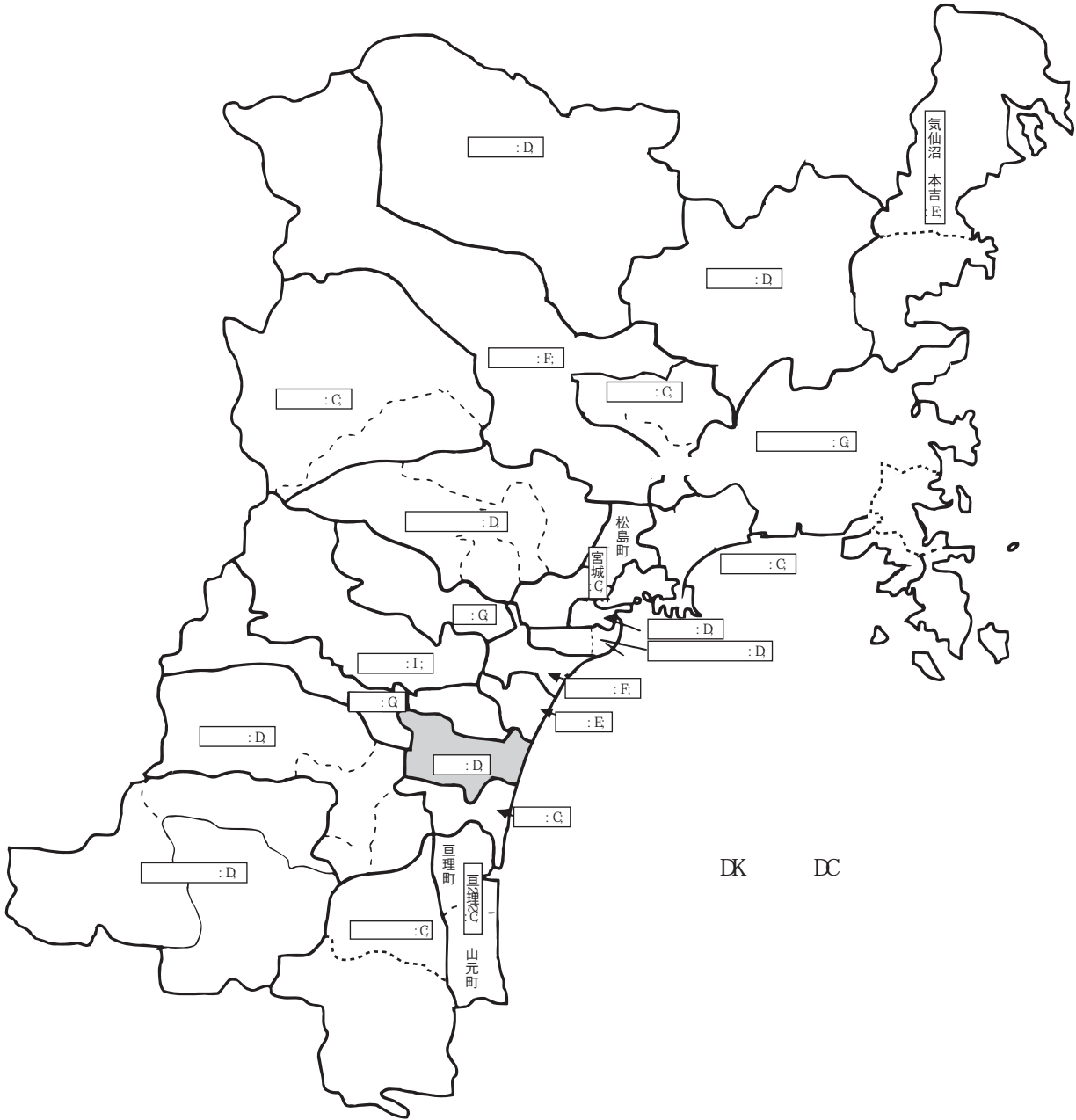

			2 2 2
	KJB JHC		BDD DCF DBDE
	KJB JIBC		BDD DDG IDCC
	KJE JHBC	CD EG	BDD DKC DCCC
	KJF JHBC		BDD DJD CCCC
	KJD JHBC	CG	BDD DFI CCCC
	KJC ECJK		BDD EID ECCC
	KJH JGBC	CF	BDDG KG CCCC
	KJG JGBC		BDD EGG HFD
	KJJ JGBC		BDDH DD EFGK
	KJK BKD		BDDF DD CECC
	KJC CKD	JB	BDD EJF DCBF
	KJC CKD	FC	BDDF HE DCDG
	KJG JGEC		BDD EHJ CCFC
	KJK DFJB	DB	BDEE DD CCCC
	KJI BGCC		BDDB DD DCKJ
	KJI DDKE		BDDJ DD CCDD
	KJC BGBE	EH	BDDG JD CCCC
	KJK HCJJ		BDDK DE KCDF
	KJC EEKD	EB	BDD EGJ ECCC
	KJK BJKD	CB	BDDF EE DDCC

	KJK BCKD	CDH	BDDF EI DCCC
	KJK CDKG	CK	BDDF GE DCCC
	KJK CEKD		BDDF JE DCCC
	KJK CHKD	FG	BDDF GG DCCC
	KJK CGKD	GI G	BDDF JF DCCC
	KJC DCKD	CDB	BDDF ID DCCI
	KJK DEKE		BDDE EF CCCC
	KJK DDKD	ED	BDDE EI CCCC
	KJC BDCG	CK	BDD EGF GI BC
	KJG JGI		BDD EGI I FEH
	KJC BCCD		BDD IH DCDJ
	KJC EHJB		BDD EFG CCCC
	KJC ECKD		BDD ECK GG BB
	KJC EHKD	HD	BDD EFG CCCC
	KJC FCKD	FC	BDDK HG DCCC
	KJC FLKD		BDDK HE ECCC
	KJI BCKD	CCE	BDDK FE DCCC
	KJI JHBD	CE	BDDK EE DCCC
	KJH DDHC	ECH	BDDG GF ECEC
	KJH BIKD	GH	BDDH FH CEI B

:G

:D



Ⓒ

	BDD	

: D

: E

:	;	

